

SYMB	REVISION	DATE	APVD.

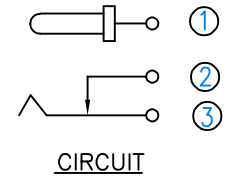

PIN DIA=2.5mm

TITLE	DC POWER JACK	DRAWN	L.Liu	TOLERANCE OTHERWISE UNLESS SPECIFIED	8					
PART NO.	XB-DS-216-25-BK	CHECKED	G.C.Chen	UP TO 5	±0.2	6	COVER	PA66	1	BLACK
DRAW NO.	D25	APPROVED	H.K.Lai	ABOVE 5 ~ 30	±0.3	5	PIN TERMINAL	C2680	1	Ag PLATED
SCALE	2:1	UNIT	mm	DATE	29-04-2013	4	BREAK TERMINAL	C2680	1	Ag PLATED
						3	TIP TERMINAL	C5210	1	Ag PLATED
						2	PIN	BRASS BAR	1	Sn PLATED
						1	HOUSING	PA66	1	BLACK
						NO.	PARTS	MATERIAL	QTY.	FINISHING

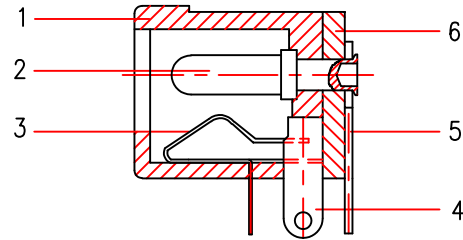
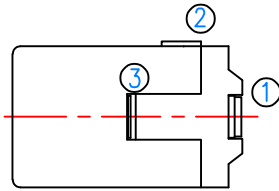
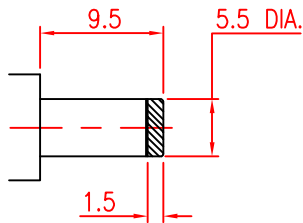
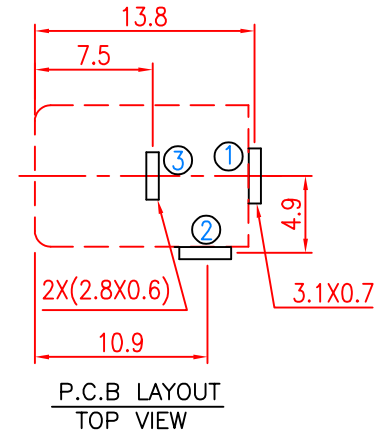
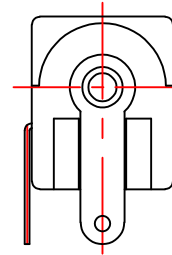
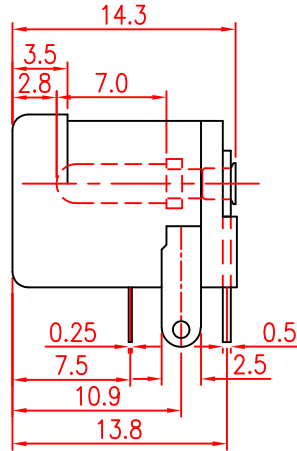
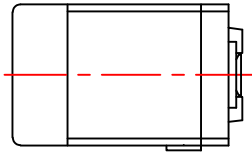
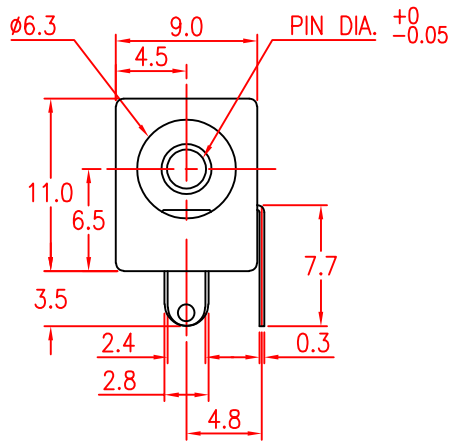