



**标准&定制开关连接器产品制造商**  
DONG GUAN XI BANG ELECTRONICS CO., LTD.

# 规格书

## SPECIFICATION

CUSTOMER NAME 客户名称: \_\_\_\_\_  
 CUSTOMER NO. 客户编号: \_\_\_\_\_  
 SERIES 系列: 拨动开关大电流系列  
 MODEL NO. 型号: XB-S105-1201G3NT1BB  
 DRAWING NO. 图形号: Sliding switch high current series

If specification of this product meets your request, please confirm all the items of it and return to us with signature and stamp, it will be basis of our production and record. Thanks your cooperation in advance!

若此产品规格符合贵司要求，敬请确认此规格书内所有项目  
 并签名和盖章后回传给我司，以作我司产品制作之  
 依据和存档之用，多谢合作！

### EXAMINE & APPROVAL 审批

APPROVE 接受	NOT APPROVE 不接受
SIGNATURE 签署      STAMP 盖章      DATE 日期	

PREPARED BY.制表人	CHECKED BY.校对	APPROVED BY.审核	APPROVAL BY. 批准
<div style="border: 1px solid red; padding: 2px; text-align: center;">研发部</div> <div style="border: 1px solid red; padding: 2px; text-align: center;">戴海明</div> <div style="border: 1px solid red; padding: 2px; text-align: center;">2022. 06. 08</div>	<div style="border: 1px solid red; padding: 2px; text-align: center;">品质部</div> <div style="border: 1px solid red; padding: 2px; text-align: center;">黄自清</div> <div style="border: 1px solid red; padding: 2px; text-align: center;">2022. 06. 08</div>	<div style="border: 1px solid red; padding: 2px; text-align: center;">工程部</div> <div style="border: 1px solid red; padding: 2px; text-align: center;">庞军</div> <div style="border: 1px solid red; padding: 2px; text-align: center;">2022. 06. 08</div>	<div style="border: 1px solid red; padding: 2px; text-align: center;">总经理办</div> <div style="border: 1px solid red; padding: 2px; text-align: center;">吴量</div> <div style="border: 1px solid red; padding: 2px; text-align: center;">2022. 06. 08</div>

**东莞市溪榜电子有限公司**

**Dong guan Xi Bang Electronics Co., Ltd**

地址: 广东省东莞市黄江镇合路工业区  
 Address: He Lu Industrial Zone, Huangjiang Town  
 ,Dongguan City, Guangdong Province  
 Tel: (0769)82055138/82056828  
 Fax: (0769)83663452

邮箱: admin@alspr.com    switch@alspr.com  
<http://www.alspr.cn/>    <http://www.alspr.com/>

**Dong Guan XB Electronics Co., Ltd**

AccountNumber: 705540238  
 BankName: Citibank N. A., HongKongBranch  
 Country/Region: Hong Kong  
 BankCode: 006  
 BankAddress: 3GardenRoad, Central, Hong Kong  
 SWIFT/BIC: CITIHKHX (CITIHKHXXXX\*If11charactersare  
 required)

MAil: HK@ALPSR.CN    XB@ALPSR.CN  
 Quality core! Afterburner for Made in China!

REV.	ECN NO.	DATE	DESCRIPTION	CHANGE BY	APPROVED BY
版本	ECN编号	日期	内容描述	变更人	核准
A0	/	19/03/16	Draft		JIMMY

规格 Specification:

- 1.额定值 Rating:1A 250VAC
- 2.接触电阻 Contact resistance:≤100 mΩ
- 3.绝缘电阻 Insulation resistance:≥100 MΩ(DC500V/Min)
- 4.电气寿命 Electronics life:> 10000 cycles
- 5.操作力 Operation force:200±100gf
- 6.所有材料符合 Rohs要求 All materials are Rohs compliant

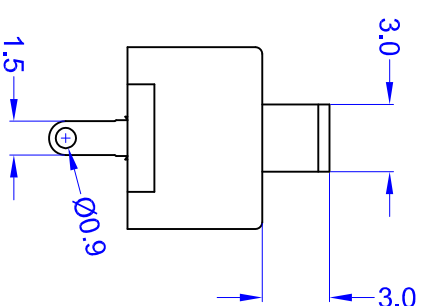
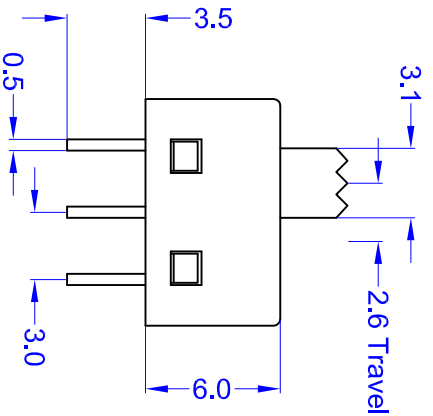
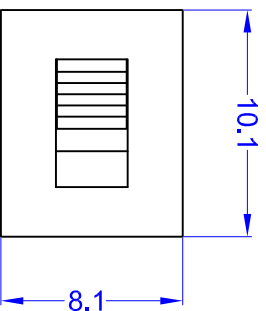

CIRCUIT



**东莞市溪榜电子有限公司**  
DONG GUAN XI BANG ELECTRONI CS CO., LTD.

DRAWN BY 制 图	<i>Jianny</i>	190316	SCALE 比例	FREE	PRODUCT NAME 产品名称	SLIDE SWITCH	
CHECKED BY 核 对	<i>Jianny</i>	190316	PAGE 页面	1/1	DESCRIPTION 产品描述	1A 250VAC	
APPROVED BY 批 准	<i>Jianny</i>	190316	UNIT 单位	mm	PART NO. 物料编号	XB-S105-1201G3NT1BB	
TOLERANCE 未标注公差			0 < L ≤ 5	±0.1	SIZE 尺寸	A4	DRAWN NO. 图纸编号
			5 < L ≤ 30	±0.2			20190316-002
			L > 30	±0.3			
			角度 ANGLES	±2°			

1	A	B	C	D	E	F	G	H
2	A	B	C	D	E	F	G	H
3	A	B	C	D	E	F	G	H
4	A	B	C	D	E	F	G	H
5	A	B	C	D	E	F	G	H
6	A	B	C	D	E	F	G	H

**H25 Series Specification H25 滑动开关规格书**
**1. General 一般描述**

1.1 Part Name 产品名称	H25 Series Slide Switch H25 系列滑动开关
1.2 Operating Temperature 使用环境温度	0°C~85°C
1.3 Function 功能	See attached drawing 见附件图纸
1.4 Standard Testing Condition 测试条件	Normal Temperature 25±10°C / Normal humidity 45~85%RH Normal atmospheric pressure 860~1060hPa 温度 25±10°C/湿度 45~85%RH/大气压力 860~1060hPa
1.5 Appearance 外观	See attached drawing 见附件图纸

**2. Approval/Rating 认证/规格**

Approval 安规认证	Rating 规格参数	Electronics life 电气寿命	Remarks 备注
UL、TUV	3(3)A 125/250VAC $\mu$ T85	10,000 Cycles	Approved

**3. Electrical Characteristics 电气特性**

NO. 序号	Item 项目	Condition 条件	Criteria 标准
3.1	Electrical life 电气寿命	10,000 life cycles 10,000 周次	Switch perform 10 cycles of normal function after max. electrical life 开关达到最大电气寿命后能继续运行 10 次
3.2	Contact resistance 接触阻抗	Initial 起始	$\cong 30m\Omega$
3.3	Insulation resistance 绝缘阻抗	Between terminals to case at 500VDC for 1minute 脚与外壳间承受 500VDC,保持 1 分钟	$\cong 100M\Omega$
3.4	Dielectric strength 耐压强度	Between terminals of contacts 1000VAC, 5mA for 1 minute 端子与端子间承受 1000VAC, 5mA,保持 1 分钟 Between terminals to button 1500VAC, 5mA for 1 minute 端子与外壳间承受 1500VAC, 5mA,保持 1 分钟	No flash or dielectric breakdown 无闪光或击穿现象



**H25 Series Specification H25 滑动开关规格书**

**4. Physical characteristics 物理特性**

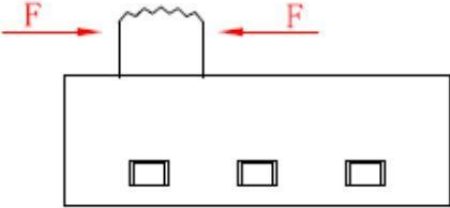
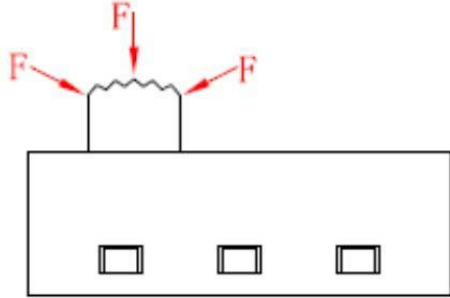
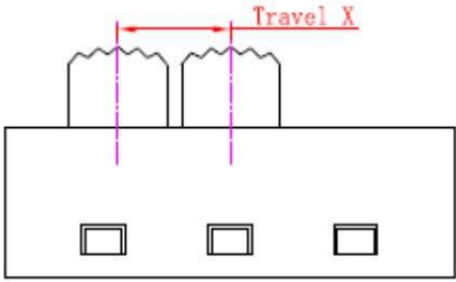
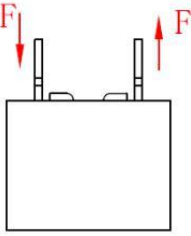
NO. 序号	Item 项目	Condition 条件	Criteria 标准
4.1	Mechanical life 机械寿命	Perform 50,000 cycles operations 50,000 周次	No detachable parts & switch / normal function 开关无损坏/功能正常
4.2	Operating force 操作力 Operating mode 操作方式	<p>Correct operation 正确操作</p>  <p>Improper operation 非正确操作</p> 	<p>Operating force: See attach drawing 操作力: 见附件图纸</p> <p>Correct operation: Horizontal force push pull the slider 正确操作: 水平力推动滑块</p> <p>Improper operation: Non horizontal force push pull the slider 非正确操作: 非水平力推动滑块</p> <p>Improper operation will affect the switch function 非正常操作将造成开关功能不良</p>
4.3	Travel 行程		See attached drawing 见附件图纸
4.4	Terminal strength 端子强度	<p>Pulling &amp; pushing force of max.3Kg apply to the terminal vertically 端子最大能承受 3Kg 垂直拔出/推入力</p> 	No detach of terminal 端子无推入及脱离现象

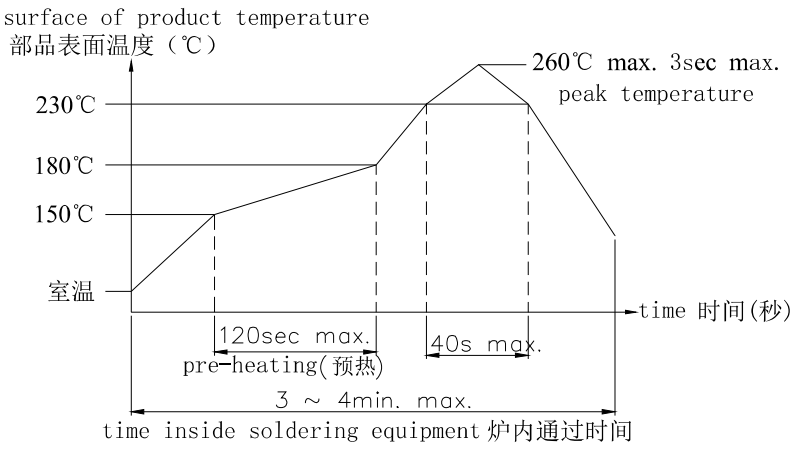

**H25 Series Specification H25 滑动开关规格书**

4.5	Solder ability of terminals 端子可焊性	Soldering temperature: 230±5°C 焊接温度 230±5°C Soldering time: 3±0.5 seconds 焊接时间 3±0.5 秒	Solder should cover minimum 50% of soldering surface 焊料最少覆盖 50%焊接表面
4.6	Hand soldering 手工焊接	Please practice according to bellow conditions: 请按以下条件进行焊接: Soldering temperature : ≤350°C 焊锡温度: ≤350°C Continuous soldering time: ≤3 Sec 连续焊接时间: ≤3 Sec	
4.7	Automatic flow soldering 自动焊接	For the product of DIP ,type solder according to the following conditions 对于 DIP 产品, 请按以下条件进行焊接 Soldering temperature : ≤260±5°C 焊锡温度: ≤260±5°C Continuous soldering time: ≤3 Sec 连续焊接时间: ≤3 Sec	
		For the product of SMT ,type solder according to the following conditions 对于 SMT 产品, 请按以下条件进行焊接  	
4.8	Flammability rating 防火等级	Thermoplastic UL 94V-0 热塑性塑料 UL 94V-0	

If the special or particular requirement are not shown in the specification, please contact our company representative for further explanation.

若在规格书内未有注明的规格, 请联系本公司的销售代表以获取详细解释。

This specification is subjected to change without prior notice.

此规格书如有更改, 恕不另行通知